

# vertbaudet

## BANQUETTE LIT GIGOGNE

### Notice de montage

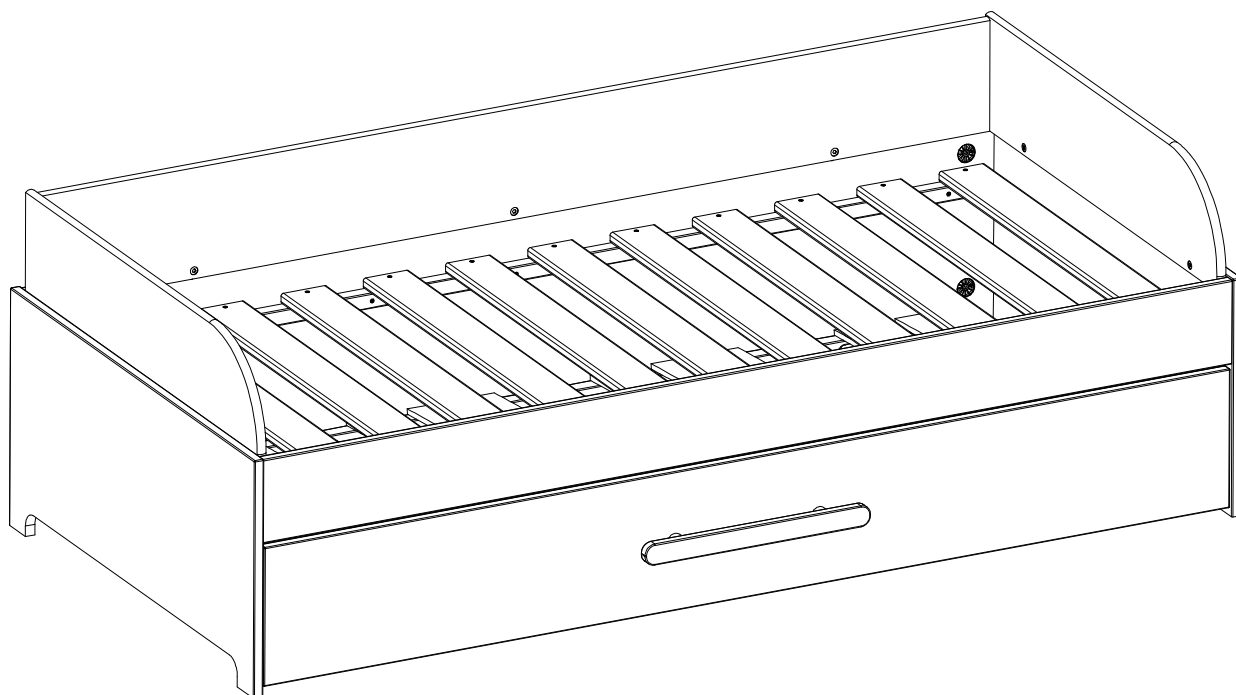

N° LOT:

Code FO: 005950  
Ref: 70501-1078

#### OUTILLAGES: Tournevis cruciforme et plat

- Bien étudier la notice de montage.
- Repérer les pièces constituant votre meuble, et contrôler la quincaillerie.
- Munissez-vous de l'outillage nécessaire.
- Aménagez-vous une zone de montage
- Ne jamais forcer sur les assemblages.
- Resserrer les vis après quelque temps d'usage.
- Garder votre notice de montage. si une pièce venait à manquer, elle serait le plusclair moyen de communiquer avec votre magasin.
- Nettoyage à l'aide d'un chiffon doux.
- Ne pas utiliser de produits à base de solvants.

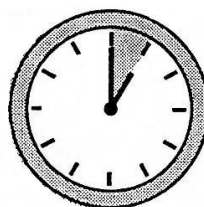

Temps pour effectuer le montage :  
1Heure

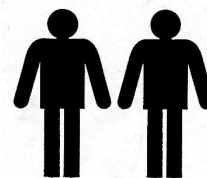

Nombre de personnes conseillé lors du montage



# BED FEASTS

## Assembly instructions

TOOLS: Philips screwdriver, Flat screwdriver

- Study the assembly instructions well.
- Carefully check the components.
- take the necessary tools
- keep a zone free for you to assemble.
- Never force the furniture during assembly.
- Tighten screws and bolts on a regular basis to prevent damage and maintain strength.
- Keep the assembly instructions for furniture reference.
- Cleaning with a soft rag.
- Do not use products solvent

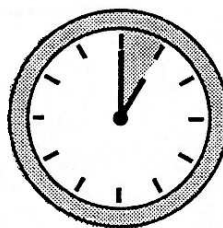

Scheduled  
assembling  
time: 1 Hour

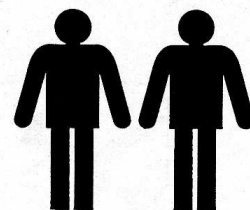

Number of poeple  
required

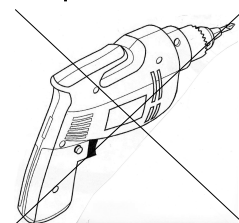

# SOFA CAMA

## Instrucciones de montaje

HERRAMIENTA: Destornillador plato y destornillador de estrella

- Consultar detenidamente las instrucciones de montaje.
- Identificar las piezas que componen el mueble, y controlar el herraje.
- Equípese de las herramientas necesarias.
- Sitúese en una zona de montaje edecuada.
- Nunca fuerce los ensamblajes.
- Volver a apretar las piezas de ensamblaje transcurrido un cierto tiempo de uso.
- Conserve estas instrucciones de montaje, en el supuesto de que faltase una pieza, sería el medio mas sencillo de comunicación con su establecimiento.
- Utilizar un paño suave para la Limpieza.
- no utilizar productos disolvente.

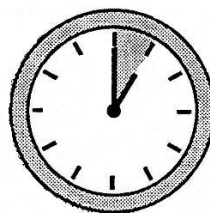

Tiempo estimado  
para efectuar el  
montaje: 1 hora

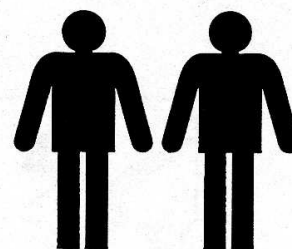

Numero de personas  
aconsejado para  
el montaje

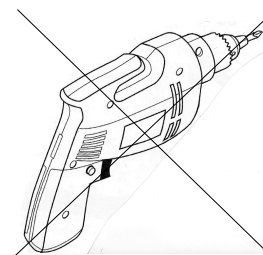

# SCHLAFCOUCH

## Montageanleitung

WERKZEUGE: Kreuzschraubenzieher, flacher Schraubendreher

- Die Montageanleitung bitte gut durchlesen.
- Überprüfen Sie sorgfältig die Komponenten.
- Benutzen Sie die angepassten Werkzeuge.
- Richten Sie sich einen Montagebereich ein.
- Niemals gewaltsam mit den Komponenten während der Montage umgehen.
- Die schrauben nach einiger Nutzungszeit bitte nachziehen.
- Bewahren Sie die Montageanleitung für die Möbel-Referenzen, der beste Weg, um mit ihrem Shop zu kommunizieren.
- Einen weichen lappen benutzen.
- Ohne Lösungsmittel reinigen.

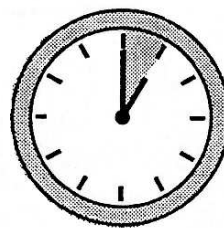

Geplante  
Montagezeit:  
1 Stunde

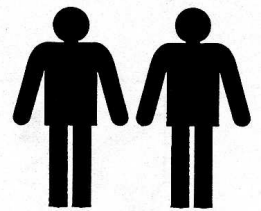

Benötigte  
Personen : 2

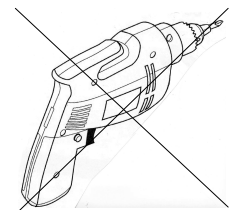

VUE ECLATÉE  
EXPLODED DIAGRAM  
DESPIECE  
EXPLOSIONSZEICHNUNG

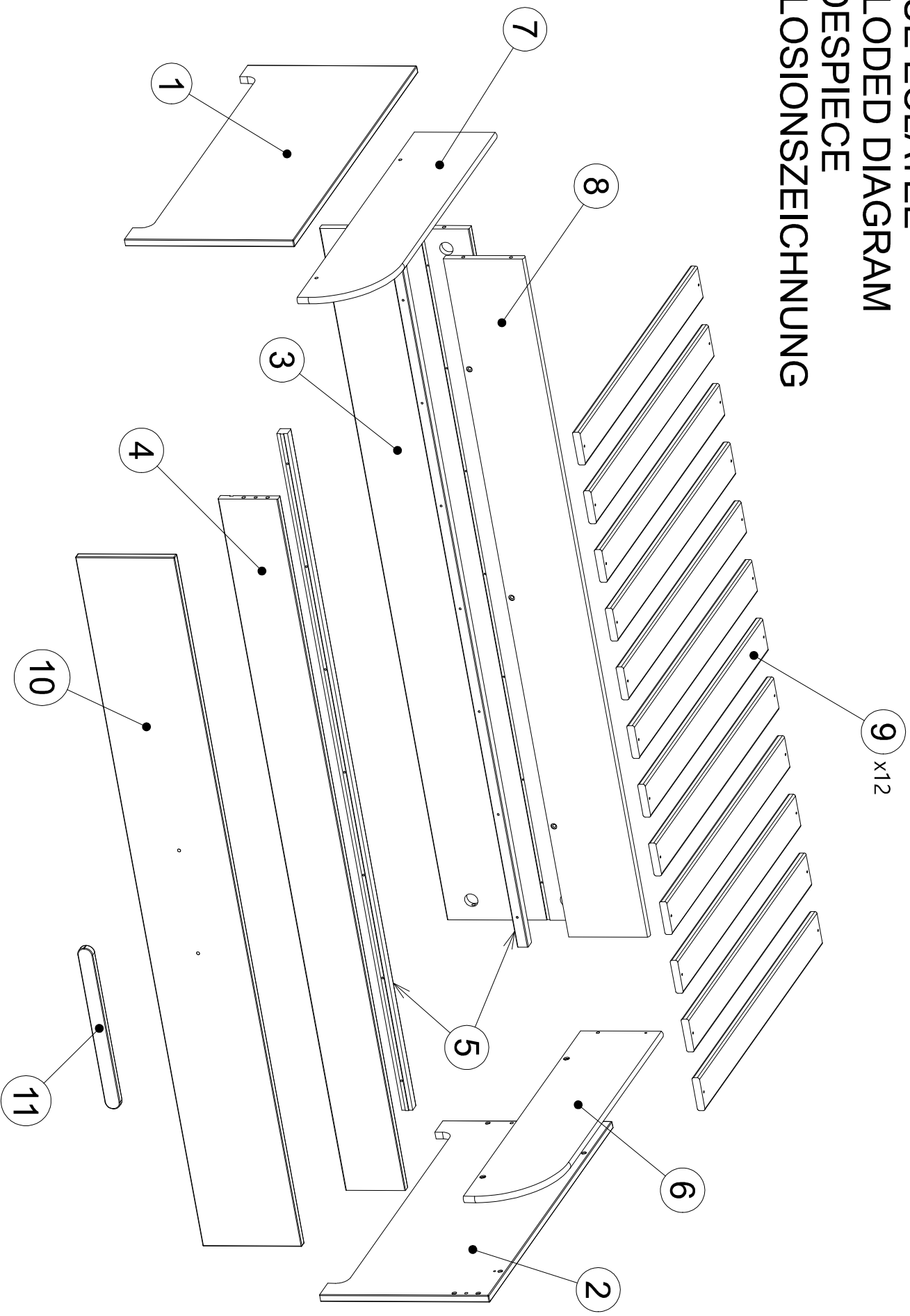

# QUINCAILLERIE, COMPONENTS, HERRAJES KOMPONENTEN

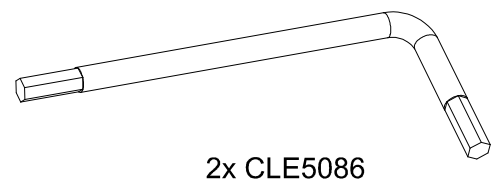
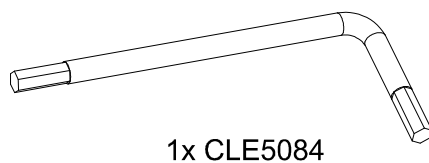
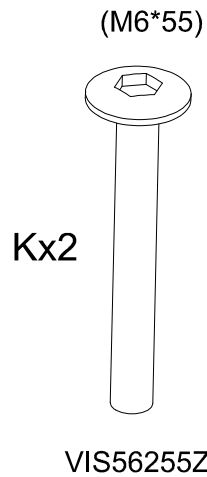
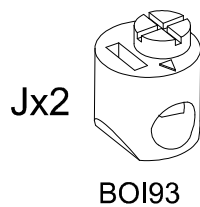
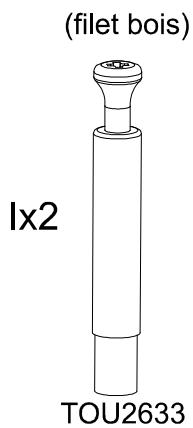
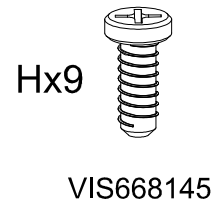
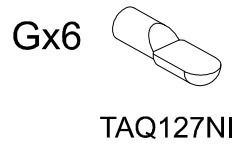
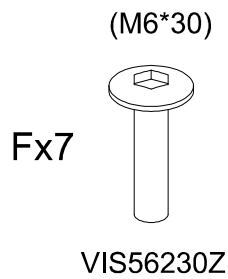
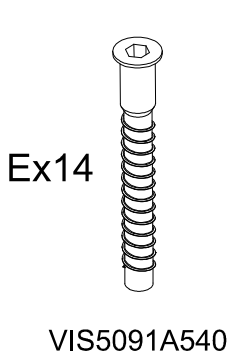
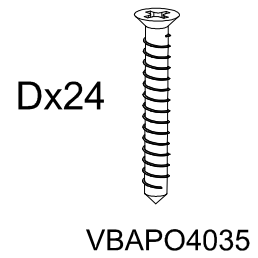
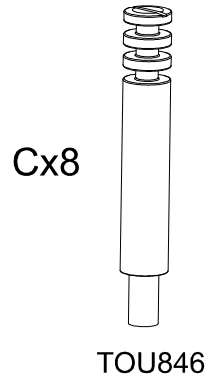
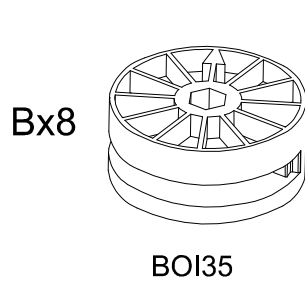
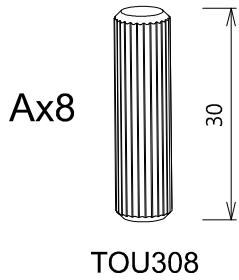

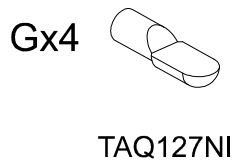
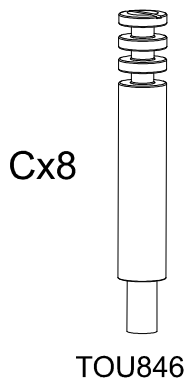
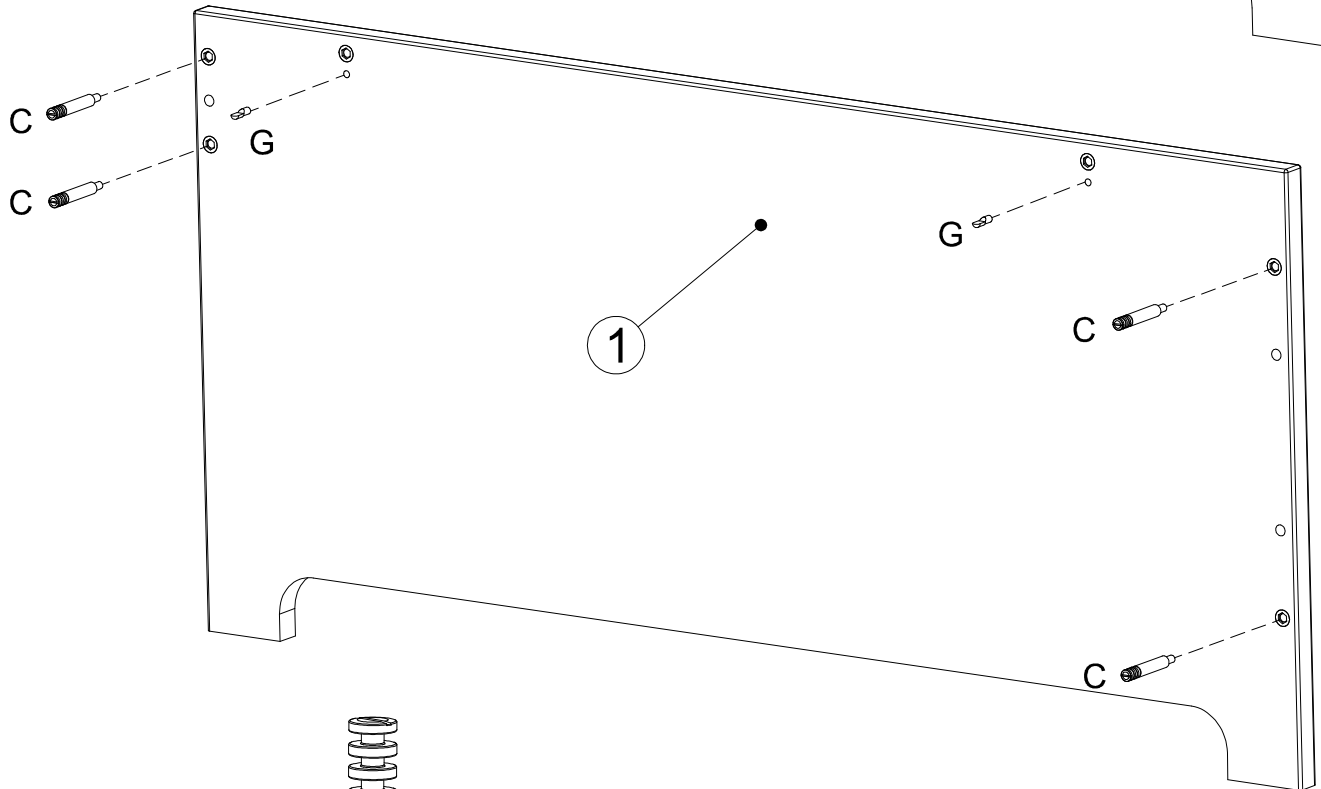
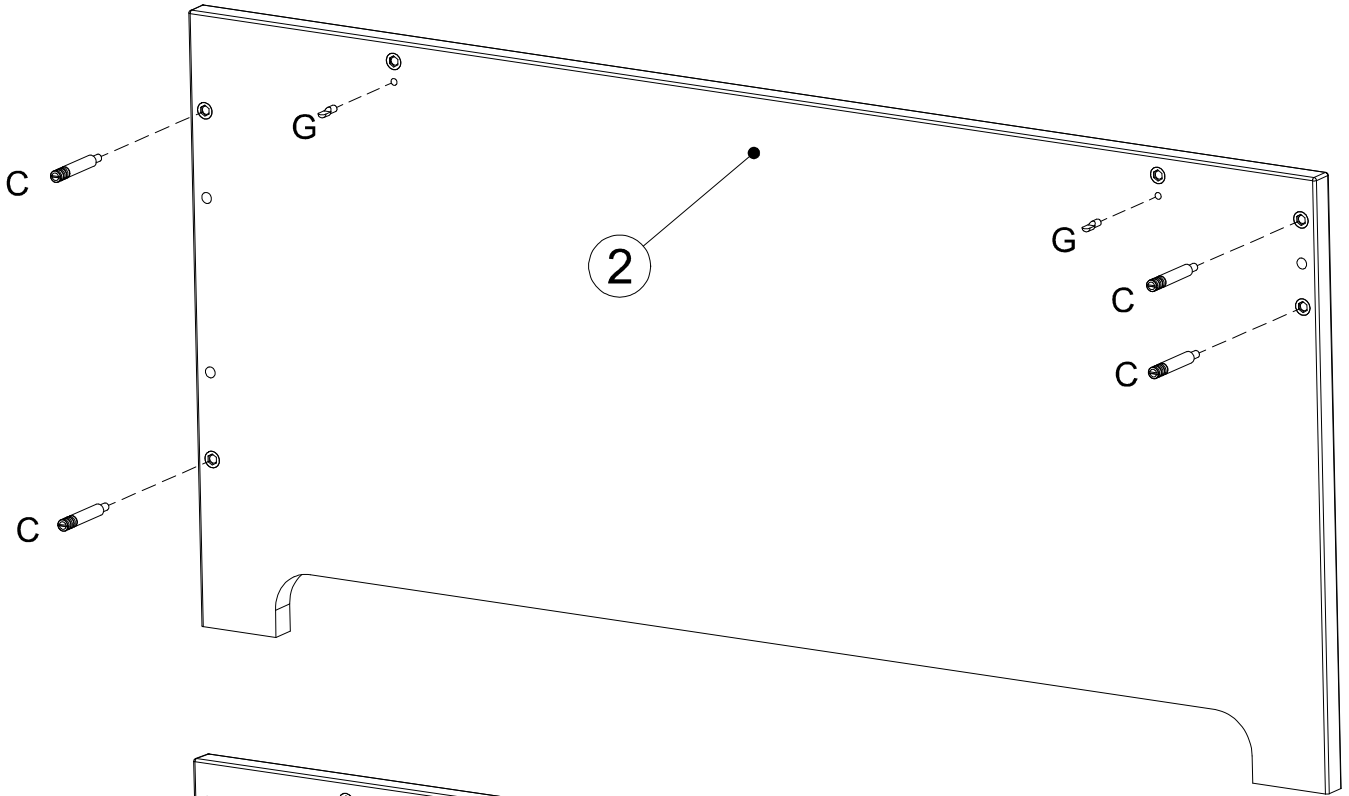

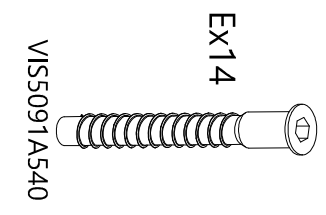
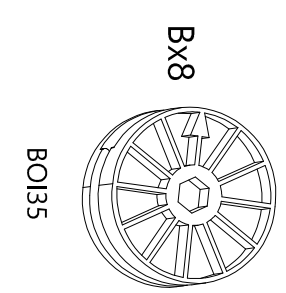
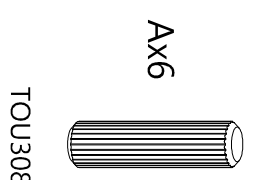
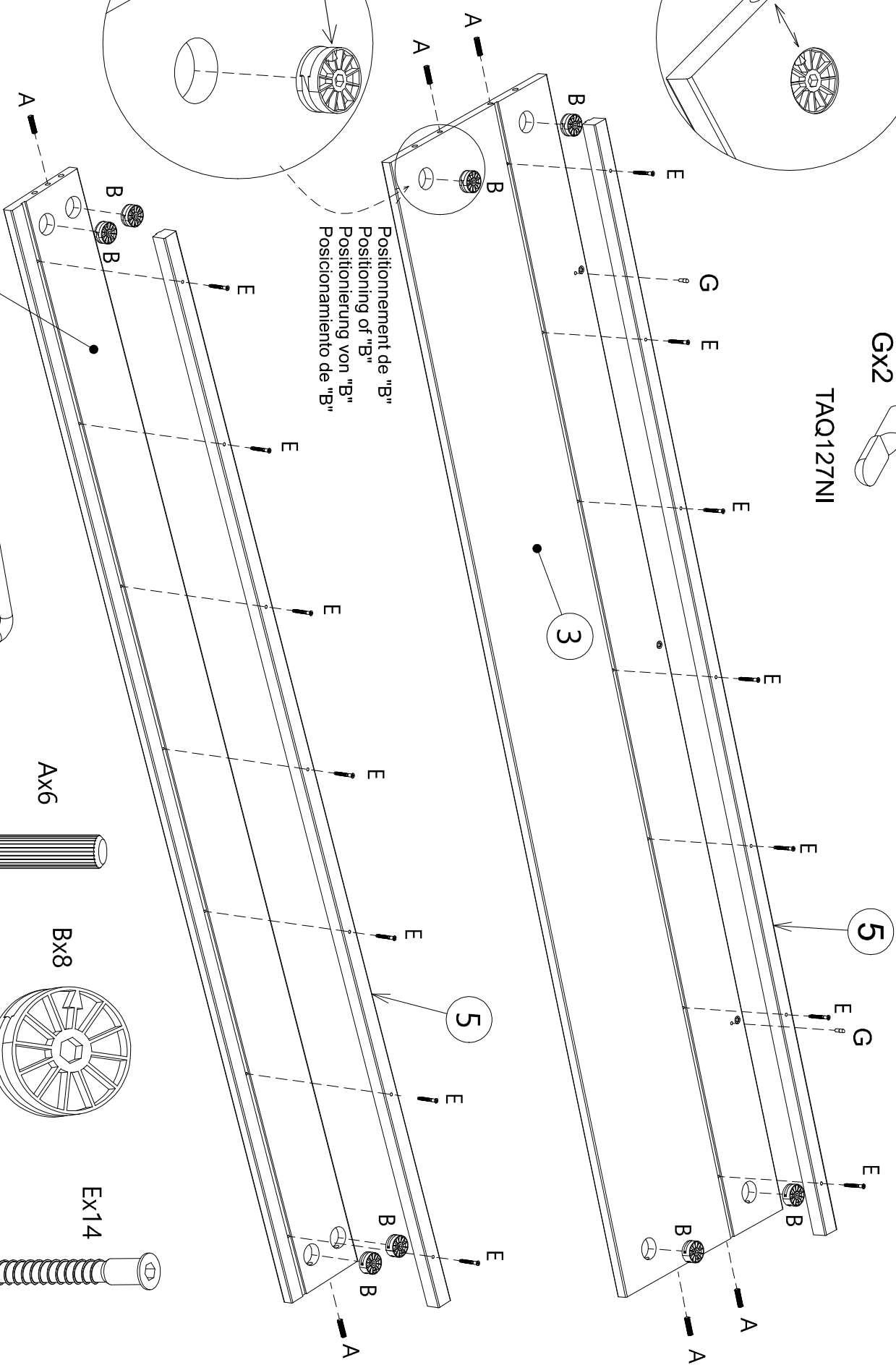
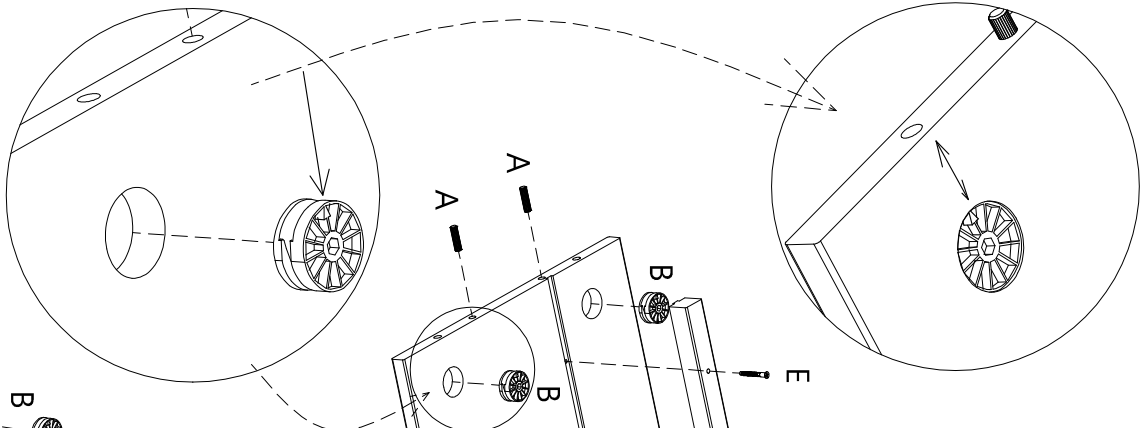

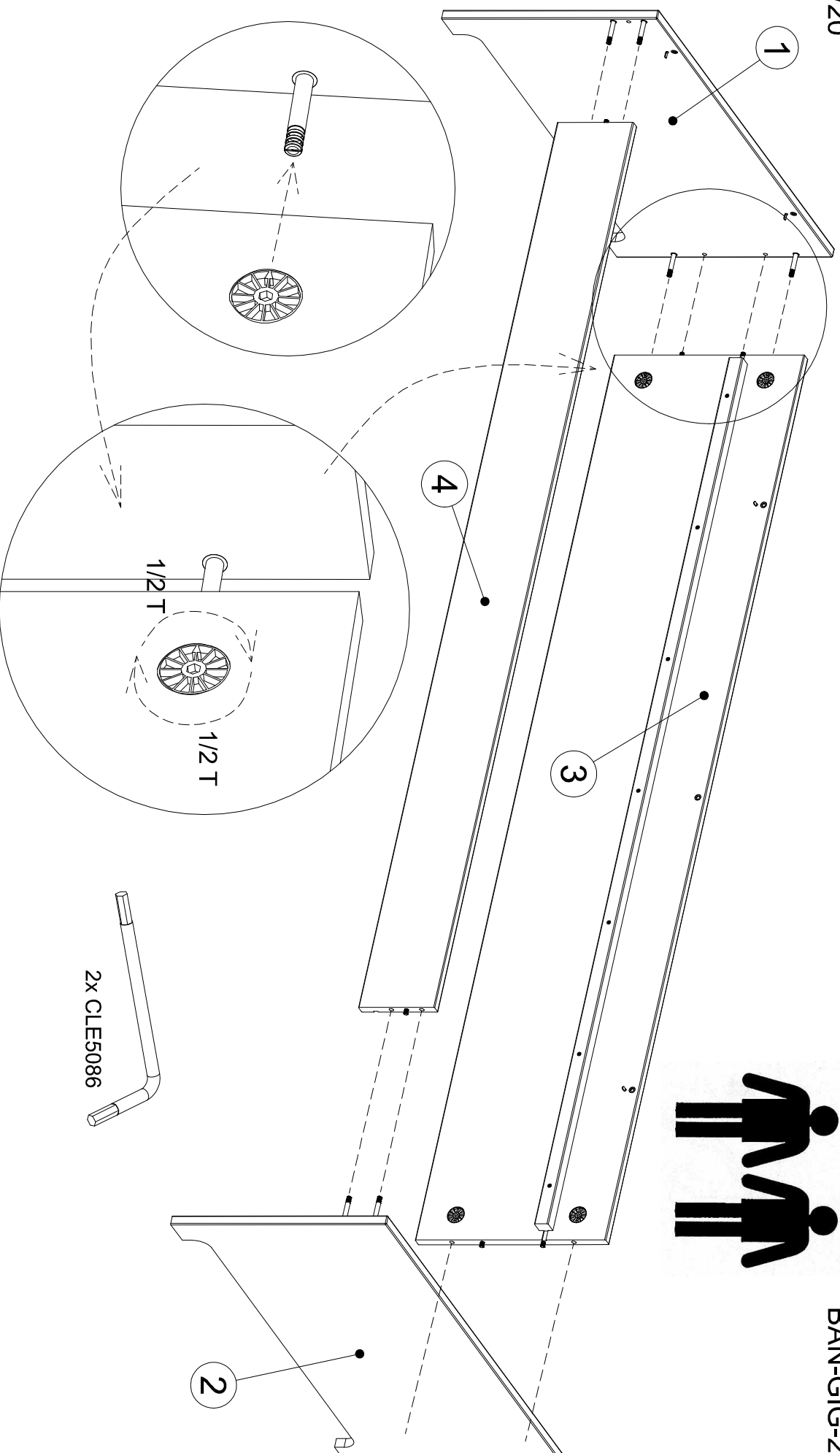

serrage 1/2T par 1/2T des pièces "B" pour l'assemblage des pans "3 et 4" sur la tête et le pied de lit

1/2T by 1/2T clamping of parts "B" for assembling the pans "3 and 4" on the head and footboard

1/2T durch 1/2T Klemmung der teile "B" zur Montage der Scheiben "3 und 4" an Kopf und Trittbrett

apriete 1/2T por 1/2T de las partes "B" para ensamblar los paneles "3 y 4" en la cabeza y el estribo



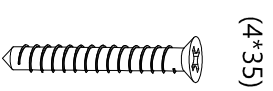

(4\*35)

Dx24

VBAP04035

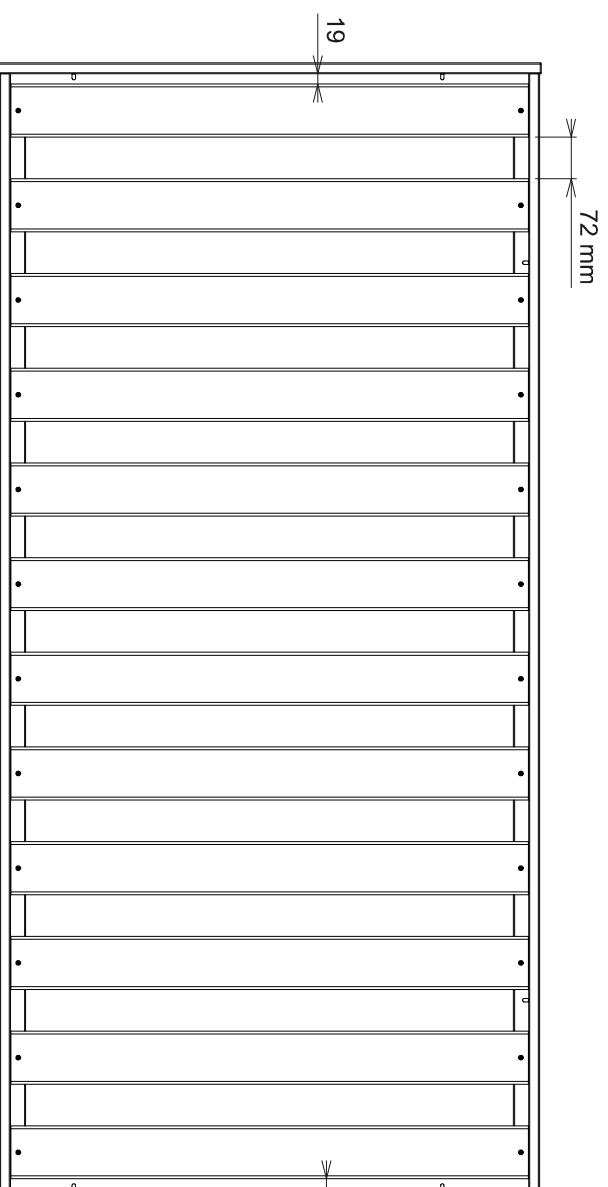
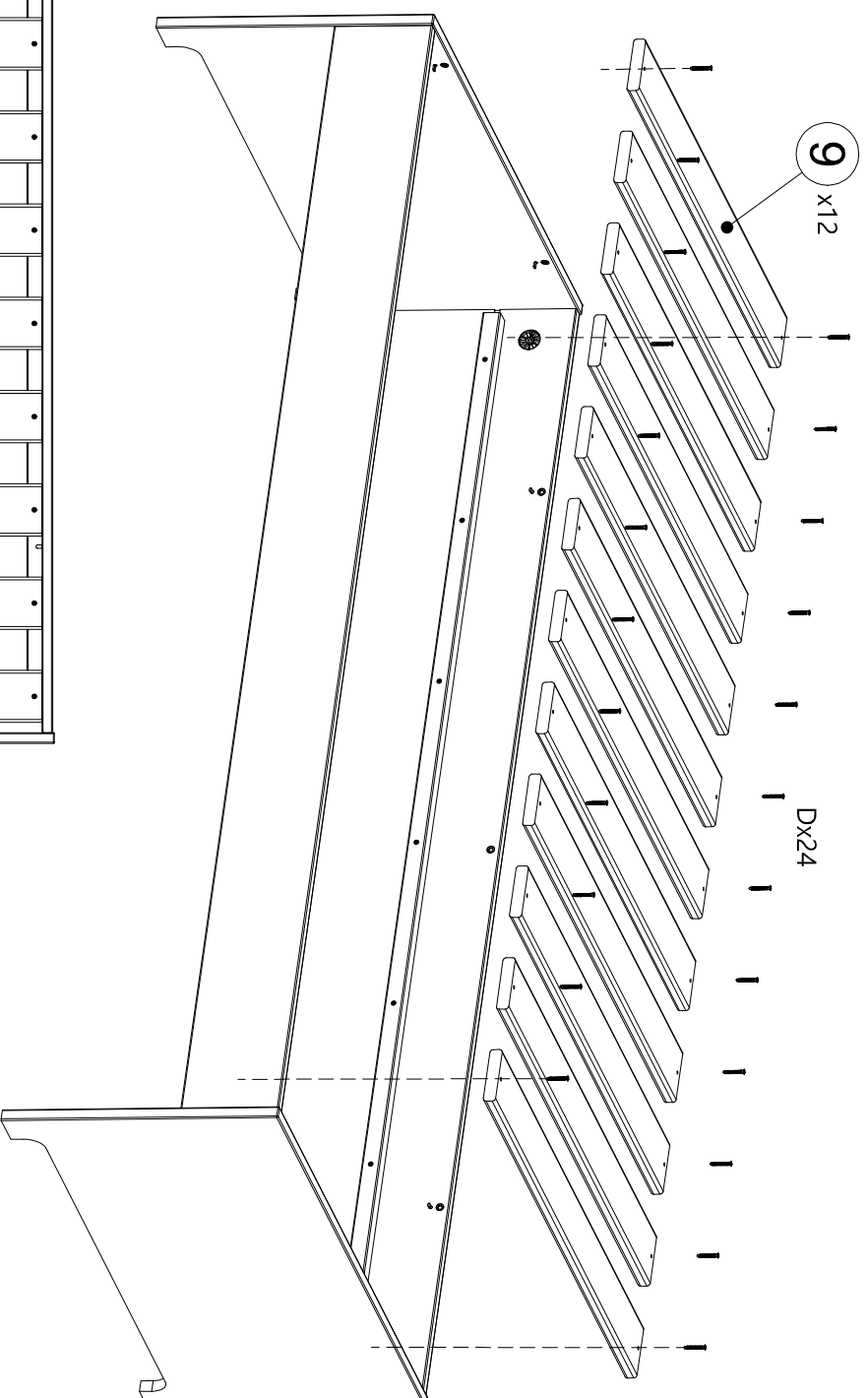

- Lattes à positionner avec cales fournies
- Slats to be positioned with shims provided
- Lamellen mit mitgelieferten Unterlegscheiben zu positionieren
- Litones para colocar con cuñas provistas

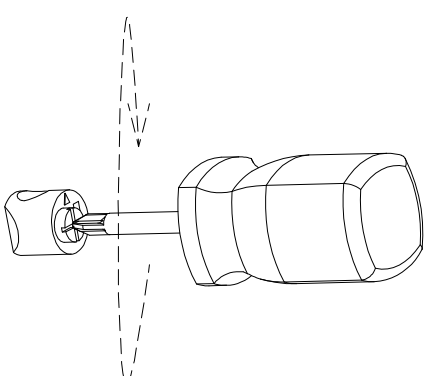
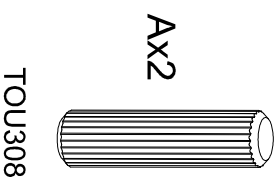
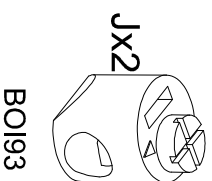
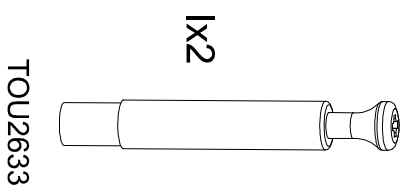
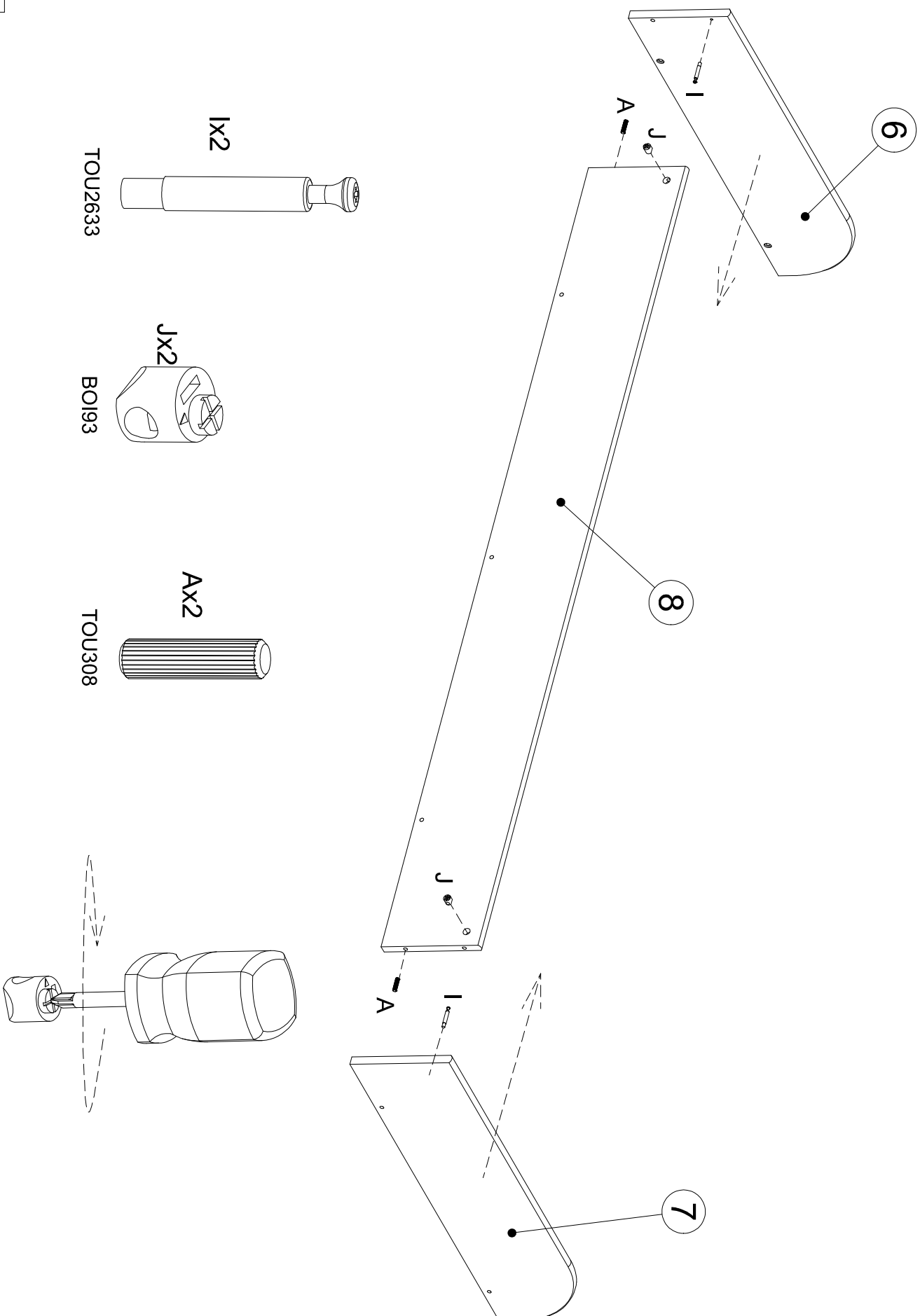

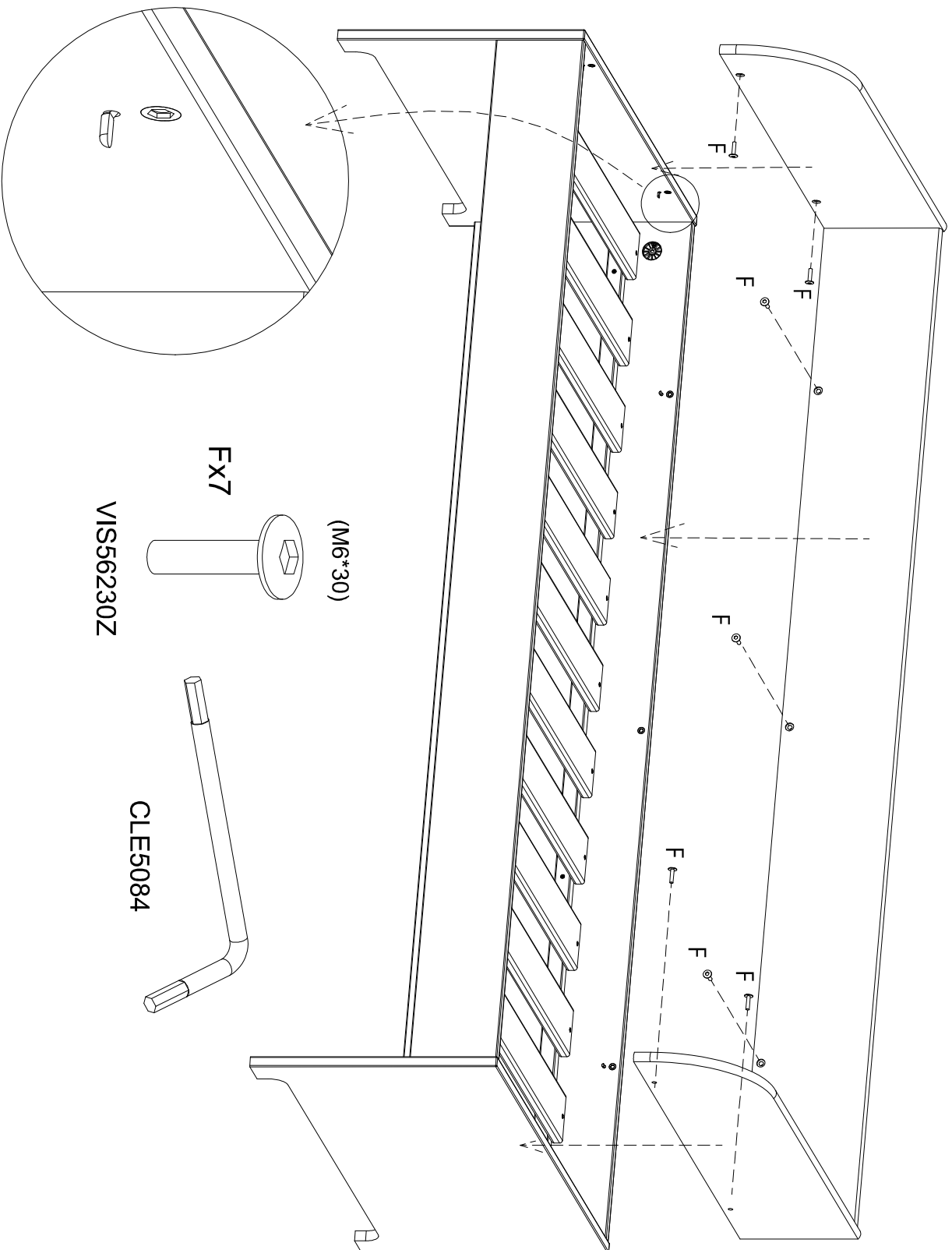

(M6\*30)

FX7

VIS56230Z

CLE5084

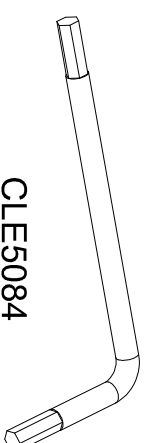
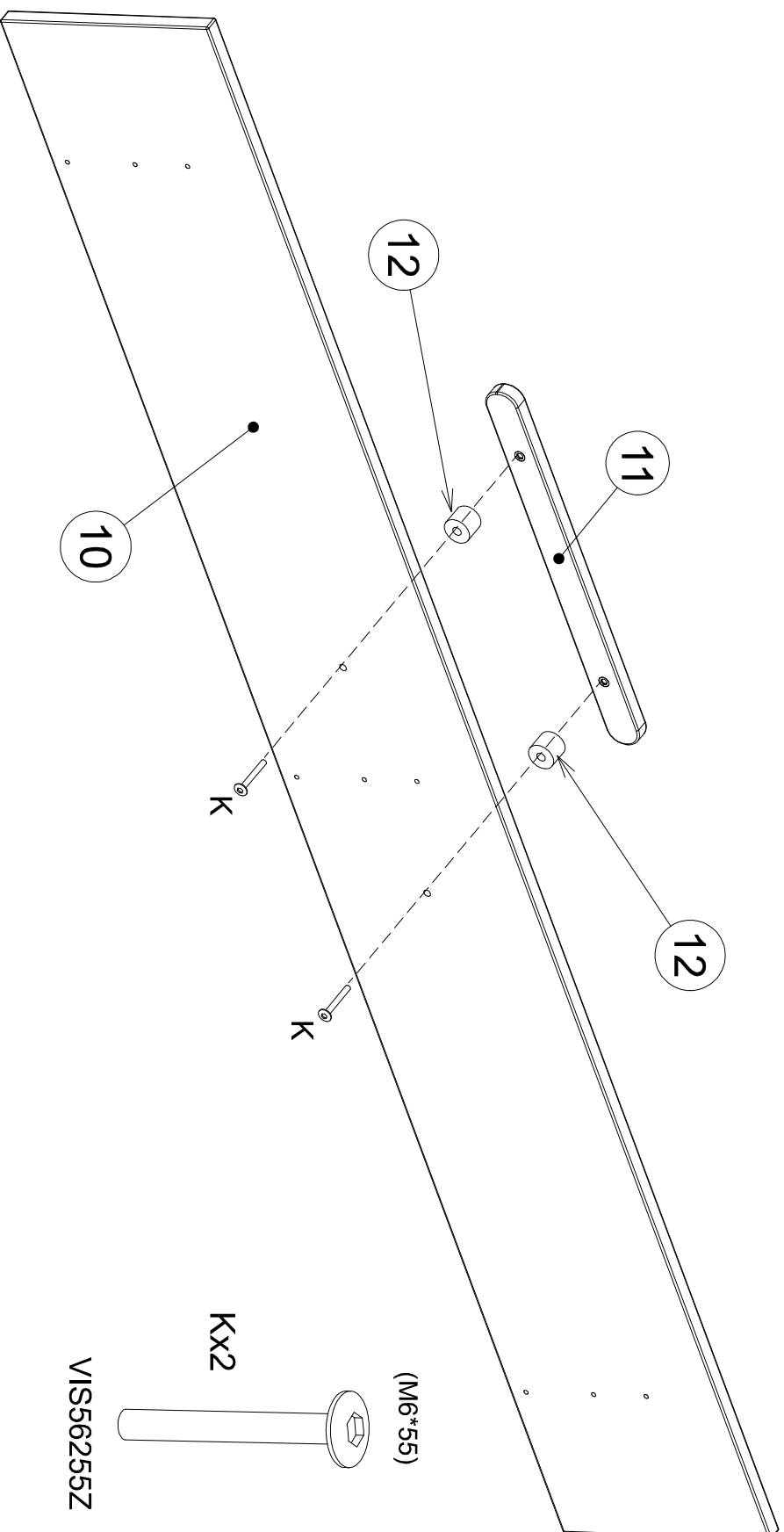

CLE5084

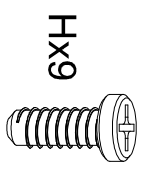
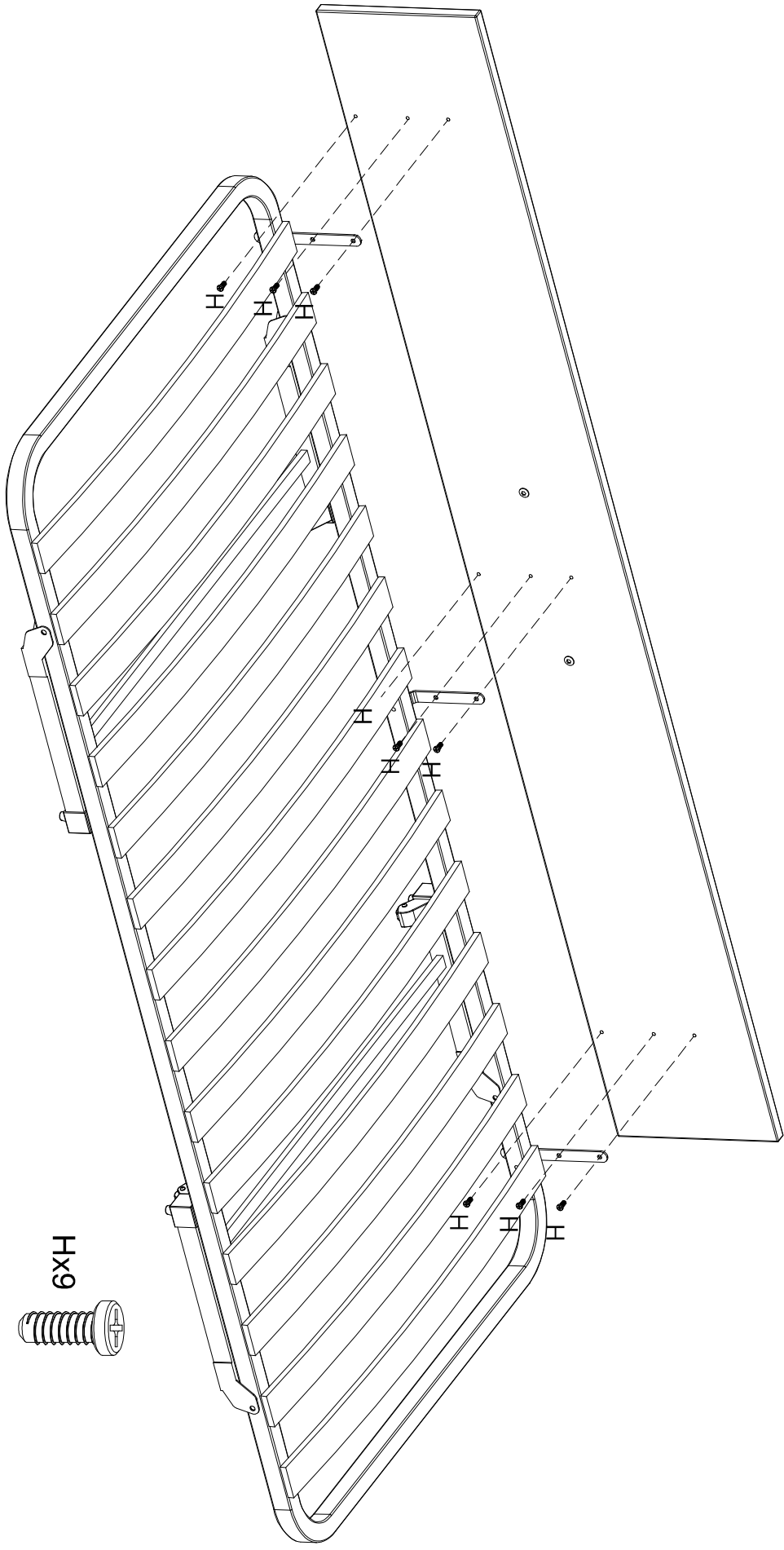

VIS668145

